



# Operation **Manual**

**DBU100H**

**Dynamic Braking Unit**



## Content

<b>Content</b> .....	<b>1</b>
<b>1 Safety precautions</b> .....	<b>2</b>
1.1 Safety definition.....	2
1.2 Warning symbols.....	2
1.3 Safety guidelines.....	2
1.3.1 Delivery and installation.....	2
1.3.2 Commission and running.....	3
1.3.3 Maintenance and replacement of components.....	4
1.3.4 Scrap treatment.....	4
<b>2 Inspection</b> .....	<b>5</b>
2.1 Unpacking inspection.....	5
2.2 Environment.....	5
2.3 Installation confirmation.....	5
<b>3 Installation guidelines</b> .....	<b>6</b>
3.1 Installation environment.....	6
3.2 Installation direction.....	7
3.3 Installation mode.....	7
3.4 External dimensions and weight.....	7
<b>4 Product name, model definition and usage</b> .....	<b>10</b>
<b>5 Installation and parameters setting</b> .....	<b>11</b>
5.1 Wiring diagram.....	11
5.2 Terminals of the main circuit.....	11
5.3 Main control terminal of the braking unit.....	12
5.4 Adjustment.....	12
5.5 Voltage selection setting.....	12
<b>6 Parallel running</b> .....	<b>14</b>
<b>7 Fault analysis and solution</b> .....	<b>15</b>
<b>8 Selection</b> .....	<b>16</b>
8.1 Guidelines of braking voltage selection.....	16
8.2 Calculation of the braking resistor and the braking current.....	16
8.3 Calculation and selection of the braking resistor.....	16
8.4 Usage standard and selection reference of the input voltage degree for adaptation DBU (220V).....	17
8.5 Usage standard and selection reference of the input voltage degree for adaptation DBU (380V).....	18
8.6 Usage standard and selection reference of the input voltage degree for adaptation DBU (660V).....	18
8.7 Selection of the braking resistors:.....	19
<b>9 Maintenance and hardware diagnostics</b> .....	<b>20</b>
9.1 Maintenance intervals.....	20
9.2 Cooling fan.....	22
9.3 Power cable.....	22





# 1 Safety precautions

## 1.1 Safety definition



<b>Danger:</b>	Serious physical injury or even death may occur if not follow relevant requirements
<b>Warning:</b>	Physical injury or damage to the devices may occur if not follow relevant requirements
<b>Note:</b>	Physical hurt may occur if not follow relevant requirements
<b>Qualified electricians:</b>	People working on the device should take part in professional electrical and safety training, receive the certification and be familiar with all steps and requirements of installing, commissioning, operating and maintaining the device to avoid any emergency.

## 1.2 Warning symbols


Warnings caution you about conditions which can result in serious injury or death and/or damage to the equipment, and advice on how to avoid the danger. Following warning symbols are used in this manual:

Symbols	Name	Instruction	Abbreviation
 Danger	Danger	Serious physical injury or even death may occur if not follow the relative requirements	
 Warning	Warning	Physical injury or damage to the devices may occur if not follow the relative requirements	
Note	Note	Physical hurt may occur if not follow the relative requirements	Note

## 1.3 Safety guidelines

	<ul style="list-style-type: none"> <li>◇ Only qualified electricians are allowed to operate.</li> <li>◇ Do not carry out any wiring and inspection or changing components when the power supply is applied.</li> </ul>
	<ul style="list-style-type: none"> <li>◇ Do not refit unauthorizedly; otherwise fire, electric shock or other injury may occur.</li> </ul>

### 1.3.1 Delivery and installation

	<ul style="list-style-type: none"> <li>◇ Please install the braking units and braking resistors on fire-retardant material and keep them away from combustible materials.</li> <li>◇ Do not use any braking unit and braking resistor with loss and damaged components.</li> <li>◇ High voltage DC current is present after connecting braking unit. Do not touch the braking unit, internal component and PCB with hands; otherwise the electric shock may occur.</li> </ul>
---	---


**Note:**

- ◇ Select appropriate moving and installing tools to ensure a safe and normal running of the dynamic braking unit and avoid physical injury or death. For physical safety, the erector

should take some mechanical protective measurements, such as wearing exposure shoes and working uniforms.

- ◇ Ensure to avoid physical shock or vibration during delivery and installation.
- ◇ Do not hold its front cover only. The cover may fall off.
- ◇ Install away from children and other public places.
- ◇ The dynamic braking unit cannot meet the requirements of low voltage protection in IEC61800-5-1 if the sea level of installation site is above 2000m.
- ◇ Please use the DBU on appropriate condition (See chapter **Installation Environment**).
- ◇ Don't allow screws, cables and other conductive items to fall inside the DBU.
- ◇ Fasten the screws while wiring, otherwise the loose wiring may cause fire or current leakage.


### 1.3.2 Commission and running

	<ul style="list-style-type: none"> <li>◇ Disconnect all power supplies applied before the terminal wiring and wait.</li> <li>◇ Only qualified electricians are allowed to operate on the dynamic braking unit.</li> <li>◇ Check the wiring before the running.</li> <li>◇ Do not touch the terminal of the control board during powering on.</li> <li>◇ Check the master details and voltage degree before running.</li> <li>◇ Do adjust and check the dynamic braking unit only after the POWER LED is totally off and the voltage between (+) and (-) is 0.</li> <li>◇ Do not touch any internal components when the dynamic braking unit is working.</li> <li>◇ The braking unit is the accessory device of the VFD. Please use it with caution because the damage to the VFD and the dynamic braking unit may occur.</li> <li>◇ Our company reserves the right to take the responsibility for the DBU (no matter it is relative to the braking unit or not). Please install the safety fuses special for the semiconductors.</li> </ul>
---	---

#### Note:

- ◇ Do not switch on or off the input power supply of the dynamic braking unit frequently.
- ◇ Ensure correct setting of the braking units and resistors.
- ◇ Do not carry out any voltage test on DBU; otherwise damage to the main circuit of the semiconductor components may occur.
- ◇ If multiple DBU are installed in a cabiner for parallel application, please install a fan or other cooling devices.
- ◇ DBU needs temperature and other protections. It is necessary to isolate the device if fault occurs to the device and cause heating. If not isolate, our company reserves the right to the accident.



**1.3.3 Maintenance and replacement of components**

	<ul style="list-style-type: none"> <li>◇ Only qualified electricians are allowed to perform the maintenance, inspection, and components replacement of the DBU.</li> <li>◇ Disconnect all power supplies to the DBU before the terminal wiring. Wait for at least the time designated on the DBU after disconnection.</li> <li>◇ Take measures to avoid screws, cables and other conductive matters to fall into the DBU during maintenance and component replacement.</li> </ul>
---	---

**Note:**

- ◇ Please select proper torque to tighten screws.
- ◇ Keep the dynamic braking unit, parts and components away from combustible materials during maintenance and component replacement.
- ◇ Do not carry out any isolation and voltage test on the dynamic braking unit and do not measure the control circuit of the dynamic braking unit by megameter.
- ◇ Carry out a sound anti-electrostatic protection to the dynamic braking unit and its internal components during maintenance and component replacement.

**1.3.4 Scrap treatment**

	<ul style="list-style-type: none"> <li>◇ There are heavy metals in the dynamic braking unit. Deal with it as industrial effluent.</li> </ul>
	<ul style="list-style-type: none"> <li>◇ When the life cycle ends, the product should enter the recycling system. Dispose of it separately at an appropriate collection point instead of placing it in the normal waste stream.</li> </ul>

## 2 Inspection

### 2.1 Unpacking inspection

Check as followings after receiving products:

1.	Check that there are no damage and humidification to the package. If not, please contact with local agents or INVT offices.
2.	Check the information on the type designation label on the outside of the package to verify that the drive is of the correct type. If not, please contact with local dealers or INVT offices.
3.	Check that there are no signs of water in the package and no signs of damage or breach to the DBU. If not, please contact with local dealers or INVT offices.
4.	Check the information on the type designation label on the outside of the package to verify that the name plate is of the correct type. If not, please contact with local dealers or INVT offices.

### 2.2 Environment

Check as followings before the actual installation and usage:


1.	Check that the ambient temperature of the DBU is below 40°C. If exceeds, derate 3% for every additional 1°C. Additionally, the DBU cannot be used if the ambient temperature is above 50°C.
2.	Check that the ambient temperature of the DBU in actual usage is above -10°C. If not, add heating facilities.
3.	Check that the altitude of the actual usage site is below 1000m. If exceeds, derate 1% for every additional 100m.
4.	Check that the humidity of the actual usage site is below 90% and condensation is not allowed. If not, add additional protection the DBU.
5.	Check that the actual usage site is away from direct sunlight and foreign objects cannot enter the DBU. If not, add additional protective measures.
6.	Check that there is no conductive dust or flammable gas in the actual usage site. If not, add additional protection to the DBU.

### 2.3 Installation confirmation

Check as followings after the installation:

1.	Check that the load range of the input and output cables meet the need of actual load.
2.	Check that the accessories of the DBU are correctly and properly installed.
3.	Check that the DBU is installed on non-flammable materials and the calorific accessories (reactors and brake resistors) are away from flammable materials.
4.	Check that all control cables and power cables are run separately and the routation complies with EMC requirement.
5.	Check that all grounding systems are properly grounded according to the requirements of the DBU.
6.	Check that the free space during installation is sufficient according to the instructions in user's manual.
7.	Check that the external connection terminals are tightly fastened and the torque is appropriate.
8.	Check that there are no screws, cables and other conductive items left in the DBU. If not, get them out.

### 3 Installation guidelines

	<ul style="list-style-type: none"> <li>◇ Only qualified electricians are allowed to carry out what described in this chapter. Please operate as the instructions in <b>Safety Precautions</b>. Ignoring these may cause physical injury or death or damage to the devices.</li> <li>◇ Ensure the power supply of the dynamic braking unit is disconnected during the operation. Wait for at least the time designated until the POWER indicator is off after the disconnection if the power supply is applied. It is recommended to use the multimeter to monitor that the DC bus voltage of the drive is under 36V.</li> <li>◇ The installation and design of the dynamic braking unit should be complied with the requirement of the local laws and regulations in the installation site. If the installation infringes the requirement, our company will exempt from any responsibility. Additionally, if users do not comply with the suggestion, some damage beyond the assured maintenance range may occur.</li> </ul>
---	--

#### 3.1 Installation environment

The installation environment is the safeguard for a full performance and long-term stable functions of the DBU. Check the installation environment as followings:

Environment	Conditions
Installation site	Indoor
Environment temperature	<ul style="list-style-type: none"> <li>◇ -10—+50°C</li> <li>◇ If the ambient temperature of the dynamic braking unit is above 40°C, derate 3% for every additional 1°C.</li> <li>◇ It is not recommended to use the dynamic braking unit if the ambient temperature is above 50°C.</li> <li>◇ In order to improve the reliability of the device, do not use the dynamic braking unit if the ambient temperature changes frequently.</li> <li>◇ Please provide cooling fan or air conditioner to control the internal ambient temperature below the required one if the dynamic braking unit is used in a close space such as in the control cabinet.</li> <li>◇ When the temperature is too low, if the dynamic braking unit needs to restart to run after a long stop, it is necessary to provide an external heating device to increase the internal temperature, otherwise damage to the devices may occur.</li> </ul>
Humidity	<ul style="list-style-type: none"> <li>◇ RH≤90%</li> <li>◇ No condensation is allowed.</li> <li>◇ The maximum relative humidity should be equal to or less than 60% in corrosive air.</li> </ul>
Storage temperature	-30—+60°C
Running environment condition	<p>The installation site of the DBU should:</p> <ul style="list-style-type: none"> <li>◇ Keep away from the electromagnetic radiation source;</li> <li>◇ Keep away from contaminative air, such as corrosive gas, oil</li> </ul>

Environment	Conditions
	mist and flammable gas; ✧ Ensure foreign objects, such as metal power, dust, oil, water cannot enter into the DBU(do not install the DBU on the flammable materials such as wood); ✧ Keep away from direct sunlight, oil mist, steam and vibration environment.
Altitude	✧ Below 1000m ✧ If the sea level is above 1000m, please derate 1% for every additional 100m.
Vibration	$\leq 5.8\text{m/s}^2(0.6\text{g})$
Installation direction	The DBU should be installed on an upright position to ensure sufficient cooling effect.

**Note:**

- ✧ DBU100H series should be installed in a clean and ventilated environment according to enclosure classification.
- ✧ Cooling air must be clean, free from corrosive materials and electrically conductive dust.

**3.2 Installation direction**

DBU100H must be installed in an upright position.

**3.3 Installation mode**

DBU100H can be installed in wall (for all frame sizes)

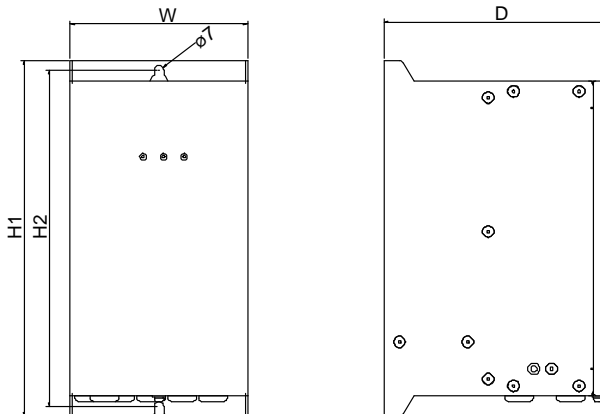
**3.4 External dimensions and weight**

Figure 3-1 Dimensions of 60A DBU



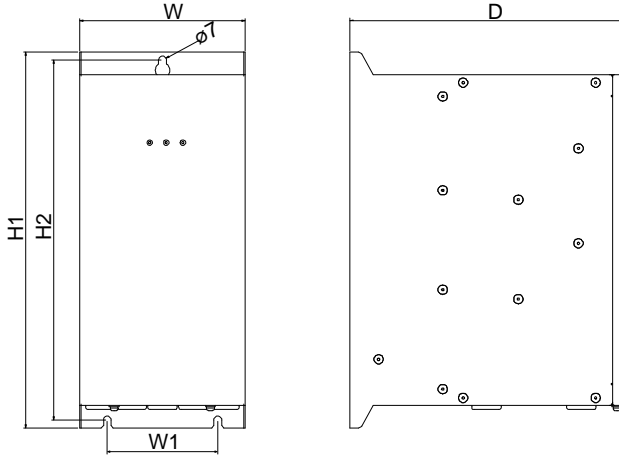


Figure 3-2 Dimensions of 110A-220A DBU

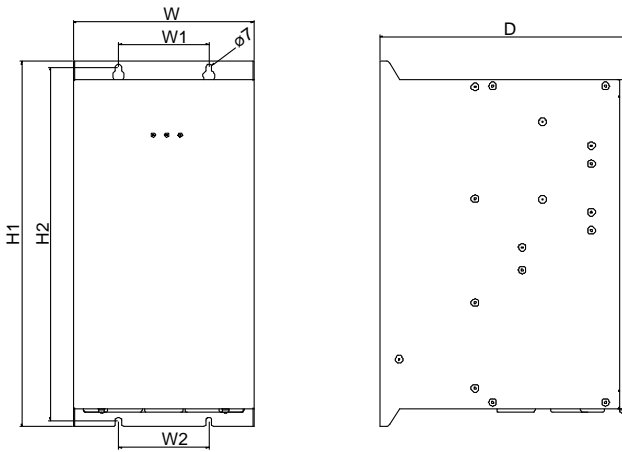


Figure 3-3 Dimensions of 320A-400A DBU

Model	W (mm)	W1 (mm)	W2 (mm)	D (mm)	H1 (mm)	H2 (mm)	Recommended mounting bolt	Weight (Kg)
DBU100H-60-2	130	/	/	163	260	246	M6*16	4
DBU100H-60-4							M6*16	4
DBU100H-110-2	150	100	/	248	340	326	M6*16	9
DBU100H-110-4							M6*16	9
DBU100H-110-6							M6*16	9

<b>Model</b>	<b>W (mm)</b>	<b>W1 (mm)</b>	<b>W2 (mm)</b>	<b>D (mm)</b>	<b>H1 (mm)</b>	<b>H2 (mm)</b>	<b>Recommended mounting bolt</b>	<b>Weight (Kg)</b>
DBU100H-160-2							M6*16	9
DBU100H-160-4							M6*16	9
DBU100H-160-6							M6*16	9
DBU100H-220-2							M6*16	9
DBU100H-220-4							M6*16	9
DBU100H-220-6							M6*16	9
DBU100H-320-4	200	100	100	275	405	391	M6*16	16
DBU100H-320-6							M6*16	16
DBU100H-400-4							M6*16	16
DBU100H-400-6							M6*16	16

## 4 Product name, model definition and usage

# DBU100H-220-4

A

B

C

D

E

F

Instruction:

Table 4-1 Product model instruction

Field identification	Detailed description of the sign
A	DBU: Dynamic braking unit
B	1: Technical version
C	00: Spare code
D	H: Heavy load type
E	Rated braking current, the unit is A
F	2: Applied on AC 3PH 220V(-15%) - 240V(+10%) and the Max. input voltage DC450V 4: Applied on AC 3PH 380V(-15%) - 440V(+10%) and the Max. input voltage DC900V 6: Applied on AC 3PH 520V(-15%) - 690V(+10%) and the Max. input voltage DC1300V

DBU100H series dynamic braking units are the high-performance and heavy-load dynamic braking units promoted by our company, which can brakes at the rated braking current to meet the application need in the situation of big inertia, crash deceleration and stop. When the DBU brakes, momentum will be converted into electric energy because of big inertia, and then the DC bus voltage will increase. The braking unit can consume the regenerative electric energy to ensure normal work of the DBU; otherwise the DBU will carry our overvoltage protection and work abnormally.

The braking unit can be used in the situation of big inertia and crash-stop. Such as elevators, textile machines, paper machinery, centrifuges, washing machines, wire drawing machines, winder, the proportion of linkage systems, crane and mining, and lifting system.

## 5 Installation and parameters setting

### 5.1 Wiring diagram

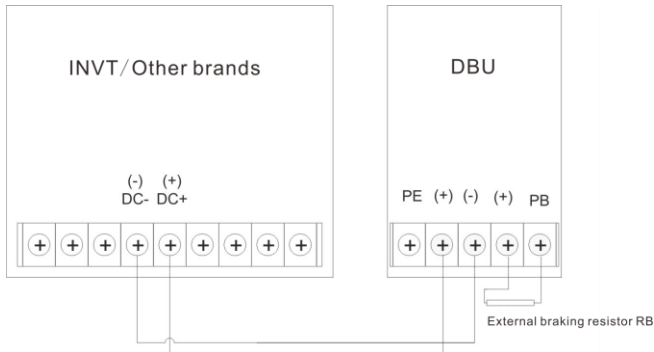


Figure 5-1 Wiring diagram of the main circuit between DBU and the VFD

**Note:**

- ✧ The wiring between the DBU and the dynamic braking unit is less than 5m.
- ✧ The wiring between the braking resistor and the braking unit is less than 10m.
- ✧ DC+ and DC- are the “+” “-” of the internal DC bus in the DBU. DC+ is the positive pole and DC- is the negative pole.

	<ul style="list-style-type: none"> <li>✧ Wrong wiring of the main circuit may cause damage to the DBU and the braking unit.</li> <li>✧ Do not touch the terminals of the control board when the machine is powering on.</li> </ul>
--	--

### 5.2 Terminals of the main circuit

PE	(+)	(-)	(+)	PB
----	-----	-----	-----	----

Figure 5-2 Terminals of main circuit 60A–220A

(+)	(+)	(+)
PE	(-)	(-)
		PB

Figure 5-3 Terminals of main circuit 320A–400A

Functions description:

Sign	Function
(+), (-)	Input terminal of the DC bus
(+), PB	External braking resistor terminal
PE	Grounding terminal. Each machine should be grounded.

### 5.3 Main control terminal of the braking unit

EFI	COM	PI	PO	COM
-----	-----	----	----	-----

ROA	ROB	ROC
-----	-----	-----

Functions description:

Sign	Function
EFI	Input terminal of the external fault. EFI-COM is defaulted to be short circuited in factory. When the external fault occurs, it will be switched off and the braking unit outputs fault signal.
PI	Slave parallel input terminals of the braking unit
PO	Master parallel output terminals of the braking unit
COM	Common terminal of EFI, PI and PO
ROA	1. Fault output terminal. When fault occurs to the braking unit, the fault relay will output fault report signal.
ROB	2.ROA NO, ROB NC, ROC is the common terminal
ROC	1. Contact Rating: 3A/AC250V, 1A/DC30V 2. Do not use it as the high frequency switch output (with cautions)



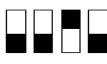

When there is only one braking unit, please connect the VFD, braking unit and braking resistor according to Figure 5-1. It will work after setting the voltage degree and the braking threshold.






### 5.4 Adjustment

The braking unit and the braking resistor need not to be adjusted. In special, do not adjust the braking unit on the situation of "voltage selection setting".

### 5.5 Voltage selection setting


The setting of braking threshold: set the voltage selection of the braking unit according to the input voltage of the DBU. The voltage selection can only performed when disconnecting the power supply. Below is the relationship between the voltage selection and the original braking voltage:

Serial No.	S1 selection	220V system (V)	380V system (V)	690V system (V)
0	1 O  1 2 3 4	350	640	1040
1	1 O  1 2 3 4	360	660	1060
2	1 O  1 2 3 4	370	680	1080
3	1 O  1 2 3 4 <b>(Factory reserved)</b>	380	700	1100

Serial No.	S1 selection	220V system (V)	380V system (V)	690V system (V)
4	1 O  1 2 3 4	390	720	1120
5	1 O  1 2 3 4	400	740	1140
6	1 O  1 2 3 4	410	760	1160
7	1 O  1 2 3 4	420	780	1180
8	1000-1110	Reserved	Reserved	Reserved
9	1 O  1 2 3 4	Slave mode	Slave mode	Slave mode

**Note:**

- ✧ If the grid voltage is above more than 20% of the normal supply, please set bigger braking voltage.
- ✧ Please ensure the allowable original braking voltage of the DBU comply with this setting.

	Do not operate during powering on. Do not adjust the setting when the POWER LED is not totally off (the voltage is present between (+) and (-)).
---	--

## 6 Parallel running

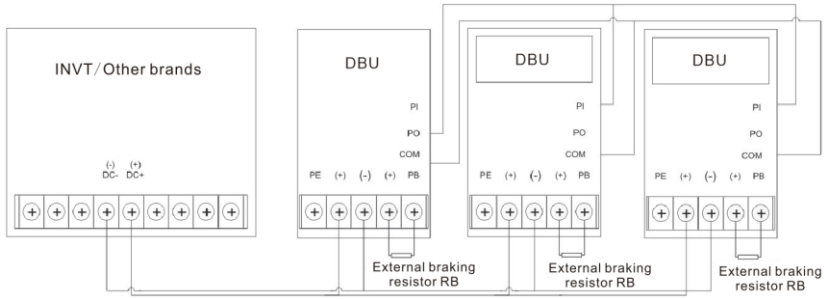


Figure 6-1 Wiring diagram between braking units in parallel operation and the VFD

When there are more than two braking units in parallel operation, connect the VFD, multiple brake units and braking resistors according to Figure 6-1.

Wiring of the control terminals: when parallel braking units are put into use, the first one is the master and the others are the slaves. The parameters setting of the slave are referred to the section 9 of “braking threshold” and the braking rate of the master and the slave need to be kept the same. The PO and COM terminal of the first braking unit is connected to the PI and COM terminal of the second braking unit and the PI and COM terminal of the third braking unit and so forth, the running of the whole parallel braking unit system can be monitored.

## 7 Fault analysis and solution

The fault can be indicated through LEDs. When the FAULT LED is on, it means the dynamic braking unit is abnormal. Check the faults one by one according to the information in the below table. Find the possible reasons and the solutions. If not, please contact with the local INVT office.

Serial No.	Fault state	Reasons	Solutions
1	Serious heat-releasing of the braking resistor during the braking	The power of the braking resistor is too low.	Change a braking resistor with bigger power.
2	Serious heat-releasing of the braking resistor when not braking	IGBT damage	Change the braking unit
		The voltage selection of the braking unit is not correct.	Reset
		Braking unit fault	Change the braking unit
3	OU of the DBU	Insufficient braking capacity of the braking resistor	Recheck the braking condition
		Wrong wiring	Check and correct
		The voltage selection of the braking unit is not correct.	Reset
		Braking unit fault	Change the braking unit
4	Output signal of the fault relay	Valid external fault input	Recheck the running condition
		Short circuit of the braking resistor	Change the braking resistor
		The temperature of IGBT is over 85°C	

**Note:** When the external grid voltage is too high, please set bigger voltage.



Non-isolated circuit is applied in the control circuit of the braking unit. Disconnect the wiring between (+) and (-) and ensure there is no voltage during the operation and checking.



## 8 Selection

### 8.1 Guidelines of braking voltage selection

The setting of the braking voltage is low enough to make the DBU works around the rated voltage and ensure a safe running. Select high braking voltage can avoid misaction of the braking unit, but too high voltage has impact on the long-term running safety.

### 8.2 Calculation of the braking resistor and the braking current

(at 100% of the braking torque)

Braking current is the DC current running through the braking unit and the braking resistor during braking.

Calculating at the standard AC motor of 380V:

P———— Rated power of the motor (kW)

V———— DC operating point of the braking unit, usually it is 700V

I———— Braking current (A)

$\eta$  ——— Conversion efficiency of the mechanical energy during feedback, usually it is 1.0

Calculation basis: the braking resistor needs to absorb all the regenerative electric energy of the motor.

Absorbed power of the braking resistor ( $V \cdot I$ ) = The regenerative electric energy of the motor ( $W$ ) =  $1000 \cdot P \cdot \eta$

### 8.3 Calculation and selection of the braking resistor

(at 100% of the braking torque)

The braking resistor reflects the braking torque in the system. If the braking torque is too small, the DBU will carry out overvoltage protection.

Calculating at the standard AC motor of 380V:

P———— Rated power of the motor (kW)

$P_R$ ———— Rated consumed power of the braking resistor (kW)

V———— DC operating point of the braking unit, usually it is 700V

R———— Equivalent resistance of the braking resistor ( $\Omega$ )

$\eta$  ——— Conversion efficiency of the mechanical energy during feedback, usually it is 1.0

$\varepsilon$  ——— Safety coefficient of the power consumption for the braking resistor  $\varepsilon = 1.4$

$K_f$ ———— Braking frequency, the time ratio of the regeneration to the whole working time

Usually,  $K_f$  is:

Winding up and winding down       $K_f = 50 - 60\%$

Oilfield machines                       $K_f = 10 - 20\%$

Elevators                                       $K_f = 10 - 15\%$

Centrifuge                                       $K_f = 5 - 20\%$

Crane(the height of lifting is more than 100m)       $K_f = 20 - 40\%$

Occasionally braking load  $K_f=5\%$

Others  $K_f=10\%$

Basis of resistor calculation: the braking resistor needs to absorb all the regenerative electric energy of the motor.

Absorbed power of the resistor  $(V^2/R) = \text{The regenerative electric energy of the motor } (W) = 1000 \cdot P \cdot \eta$

Basis of resistor power calculation:

The regenerative electric energy of the motor needs to be absorbed by the resistor and converted into heat to release.

$$P_R = P \cdot K_f \cdot \eta \cdot \varepsilon = P \cdot K_f \cdot 1.0 \cdot 1.4$$

#### 8.4 Usage standard and selection reference of the input voltage degree for adaptation DBU (220V)

Below is the selection reference when the DC operating point of the braking unit is 380V:

Power	Model	100% of the adaptation braking resistor of the braking torque(Ω)	Dissipated power of the braking resistor(kW) (10% of the braking)	Dissipated power of the braking resistor(kW) (50% of the braking)	Dissipated power of the braking resistor(kW) (80% of the braking)	Mini allowable braking resistor(Ω)
15kW	DBU100H-60-2	9.6	2	11	18	6.4
18kW		8.0	3	14	22	
22kW		6.5	3	17	26	
30kW	DBU100H-110-2	4.8	5	23	36	3.5
37kW		3.9	6	28	44	
45kW	DBU100H-160-2	3.2	7	34	54	2.4
55kW		2.6	8	41	66	
75kW	DBU100H-220-2	1.9	11	56	90	1.8
90kW	Two	1.6	7*2	34*2	54*2	2.4*2
110kW	DBU100H-160-2	1.3	9*2	43*2	66*2	

## 8.5 Usage standard and selection reference of the input voltage degree for adaptation DBU (380V)

Below is the selection reference when the DC operating point of the braking unit is 700V:

Power	Model	100% of the adaptation braking resistor of the braking torque( $\Omega$ )	Dissipated power of the braking resistor(kW) (10% of the braking)	Dissipated power of the braking resistor(kW) (50% of the braking)	Dissipated power of the braking resistor(kW) (80% of the braking)	Mini allowable braking resistor( $\Omega$ )
37kW	DBU100H-60-4	13.2	6	28	44	11.7
45kW	DBU100H-110-4	10.9	7	34	54	6.4
55kW		8.9	8	41	66	
75kW		6.5	11	56	90	
90kW	DBU100H-160-4	5.4	14	68	108	4.4
110kW		4.5	17	83	132	
132kW	DBU100H-220-4	3.7	20	99	158	3.2
160kW	DBU100H-320-4	3.1	24	120	192	2.2
200kW		2.5	30	150	240	
220kW	DBU100H-400-4	2.2	33	165	264	1.8
250kW		2.0	38	188	300	
280kW		Two DBU100H-320-4	3.6*2	21*2	105*2	
315kW	3.2*2		24*2	118*2	189*2	
350kW	2.8*2		27*2	132*2	210*2	
400kW	2.4*2		30*2	150*2	240*2	
500kW	Two DBU100H-400-4	2*2	38*2	186*2	300*2	1.8*2

## 8.6 Usage standard and selection reference of the input voltage degree for adaptation DBU (660V)

Below is the selection reference when the DC operating point of the braking unit is 1100V:

Power	Model	100% of the adaptation braking resistor of the braking torque( $\Omega$ )	Dissipated power of the braking resistor(kW) (10% of the braking)	Dissipated power of the braking resistor(kW) (50% of the braking)	Dissipated power of the braking resistor(kW) (80% of the braking)	Mini allowable braking resistor( $\Omega$ )
37kW	DBU100H-110-6	32.7	6	28	44	10.0
45kW		26.9	7	34	54	
55kW		22.0	8	41	66	
75kW		16.1	11	56	90	

Power	Model	100% of the adaptation braking resistor of the braking torque( $\Omega$ )	Dissipated power of the braking resistor(kW) (10% of the braking)	Dissipated power of the braking resistor(kW) (50% of the braking)	Dissipated power of the braking resistor(kW) (80% of the braking)	Mini allowable braking resistor( $\Omega$ )
90kW		13.4	14	68	108	
110kW		11.0	17	83	132	
132kW	DBU100H-160-6	9.2	20	99	158	6.9
160kW		7.6	24	120	192	
200kW	DBU100H-220-6	6.1	30	150	240	5.0
220kW		5.5	33	165	264	
250kW	DBU100H-320-6	4.8	38	188	300	3.4
280kW		4.3	42	210	336	
315kW		3.8	47	236	378	
350kW		3.5	53	263	420	
400kW	DBU100H-400-6	3.0	60	300	480	2.8
500kW	Two	4.8*2	38*2	186*2	300*2	5.0*2
560kW	DBU100H-320-6	4.4*2	42*2	210*2	336*2	

### 8.7 Selection of the braking resistors:

- ◇ It is recommended to apply non-inductive resistance to reduce the inductance.
- ◇ The protective devices for auto-partitioning during overheating are necessary.
- ◇ The grounding fault is prohibited; otherwise the damage to the device and DBU may occur.
- ◇ The capacity of the braking resistor is the reference value and it can be modified according to the inertial loads, braking frequency, braking voltage threshold. Please consult with our company for more information.
- ◇ Our company also has cement resistor and big power printing resistor and non inductive resistance to sell.

#### Note:

- ◇ Parallel braking unit can enlarge the braking capacity.
- ◇ The braking capacity of 2 parallel braking units is two times of one braking unit. For example DBU100H-220-4=DBU100H-110-4\*2.

## 9 Maintenance and hardware diagnostics

### 9.1 Maintenance intervals

If installed in an appropriate environment, the dynamic braking unit requires very little maintenance. The table lists the routine maintenance intervals recommended by INVT.

Checking part		Checking item	Checking method	Criterion
Ambient environment		Check the ambient temperature, humidity and vibration and ensure there is no dust, gas, oil fog and water drop.	Visual examination and instrument test	Conforming to the manual
		Ensure there are no tools or other foreign or dangerous objects	Visual examination	There are no tools or dangerous objects.
Voltage		Ensure the main circuit and control circuit are normal.	Measurement by millimeter	Conforming to the manual
Keypad		Ensure the display is clear enough	Visual examination	The characters are displayed normally.
		Ensure the characters are displayed totally	Visual examination	Conforming to the manual
Main circuit	For public use	Ensure the screws are tightened securely.	Tighten up	NA
		Ensure there is no distortion, crackles, damage or color-changing caused by overheating and aging to the machine and insulator.	Visual examination	NA
		Ensure there is no dust and dirtiness	Visual examination	NA <b>Note:</b> If the color of the copper blocks change, it does not mean that there is something wrong with the features.
	The lead of the conductors	Ensure that there is no distortion or color-changing of the conductors caused by	Visual examination	NA

Checking part		Checking item	Checking method	Criterion
		overheating.		
		Ensure that there are no crackles or color-changing of the protective layers.	Visual examination	NA
	Terminals seat	Ensure that there is no damage	Visual examination	NA
	Resistors	Ensure whether there is replacement and splitting caused by overheating.	Smelling and visual examination	NA
		Ensure that there is no offline.	Visual examination or remove one ending to coagulate or measure with multimeters	The resistors are in $\pm 10\%$ of the standard value.
Control circuit	PCB and plugs	Ensure there is no loose screws and contactors.	Fasten up	NA
		Ensure there is no smelling and color-changing.	Smelling and visual examination	NA
		Ensure there are no crackles, damage distortion and rust.	Visual examination	NA
		Ensure there is no weeping and distortion to the capacitors.	Visual examination or estimate the usage time according to the maintenance information	NA
Cooling system	Cooling fan	Estimate whether there is abnormal noise and vibration.	Hearing and Visual examination or rotate with hand	Stable rotation
		Estimate there is no losses screw.	Tighten up	NA
		Ensure there is no color-changing caused by overheating.	Visual examination or estimate the usage time according to the maintenance information	NA

Checking part		Checking item	Checking method	Criterion
	Ventilating duct	Ensure whether there is stuff or foreign objection in the cooling fan, air vent.	Visual examination	NA


Consult the local INVT Service representative for more details on the maintenance. Visit the official website of INVT: <http://www.invt.com.cn> and select Services and Support in the front page to go to online service.

## 9.2 Cooling fan

The dynamic braking unit's cooling fan has a minimum life span of 25,000 operating hours. The actual life span depends on the usage and ambient temperature.


Fan failure can be predicted by the increasing noise from the fan bearings. If the braking unit is operated in a critical part of a process, fan replacement is recommended once these symptoms appear. Replacement fans are available from INVT.

### Replacing the cooling fan

	Read and follow the instructions in chapter <i>Safety Precautions</i> . Ignoring the instructions would cause physical injury or death, or damage to the equipment.
---	---

1. Stop the DBU and disconnect it from the AC power source and wait for at least the time designated on the DBU.
2. Lever the fan holder off the drive frame with a screwdriver and lift the hinged fan holder slightly upward from its front edge.
3. Free the fan cable from the clip.
4. Disconnect the fan cable.
5. Remove the fan holder from the hinges.
6. Install the new fan holder including the fan in reverse order.
7. Restore power.

## 9.3 Power cable

	Read and follow the instructions in chapter <i>Safety Precautions</i> . Ignoring the instructions may cause physical injury or death, or damage to the equipment.
---	---

1. Stop the drive and disconnect it from the power line. Wait for at least the time designated on the braking unit.
2. Check the tightness of the power cable connections.
3. Restore power.



Service line: 86-755-23535967 E-mail: overseas@invt.com.cn Website: www.invt.com

The products are owned by **Shenzhen INVT Electric Co.,Ltd.**

Two companies are commissioned to manufacture: (For product code, refer to the 2nd/3rd place of S/N on the name plate.)

**Shenzhen INVT Electric Co., Ltd.** (origin code: 01)

Address: INVT Guangming Technology Building, Songbai Road,  
Matian, Guangming District, Shenzhen, China

**INVT Power Electronics (Suzhou) Co., Ltd.** (origin code: 06)

Address: 1# Kunlun Mountain Road, Science&Technology Town,  
Gaoxin District, Suzhou, Jiangsu, China

- Industrial Automation:** ■ HMI ■ PLC ■ VFD ■ Servo System  
■ Elevator Intelligent Control System ■ Rail Transit Traction System
- Energy & Power:** ■ UPS ■ DCIM ■ Solar Inverter ■ SVG  
■ New Energy Vehicle Powertrain System ■ New Energy Vehicle Charging System  
■ New Energy Vehicle Motor



66001-00143

Copyright© INVT.

Manual information may be subject to change without prior notice.

202206 (V1.8)